

TCH-23303.S 16MM
Drawer and Cabinet Specifications



Drawer box specification

Drawer back preparation

Rear view

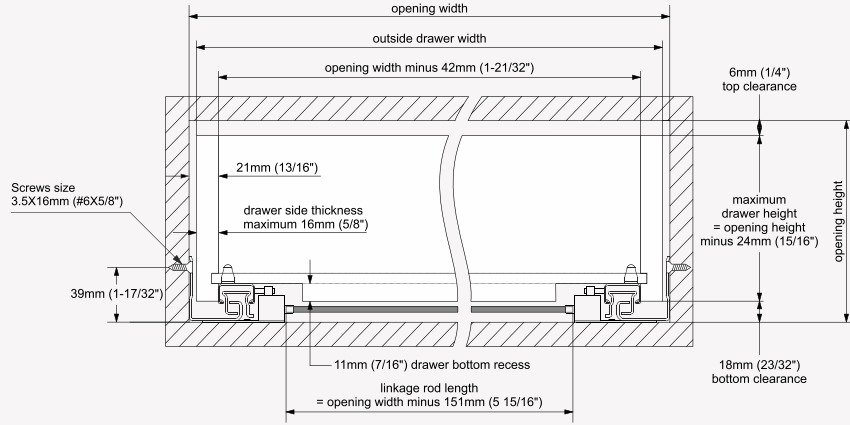

Rear view

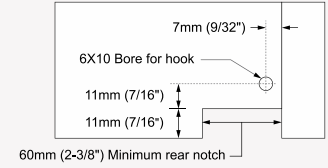

Note: The inside drawer width must equal Cabinet opening width minus 42mm (1-21/32") to align and function optimally

Calculating outside drawer width

For drawer side panel thickness	16mm (5/8")	15mm (19/32")	14mm (9/16")	13mm (1/2")	12mm (15/32")
Deduct from inside cabinet width	10mm (3/8")	12mm (15/32")	14mm (9/16")	16mm (5/8")	18mm (23/32")

Example: For 508mm (20") inside cabinet width and a 16mm (5/8") thick drawer panel, 508mm (20") minus 10mm (3/8") = 498mm (19 5/8") drawer width.

Runner mounting specifications

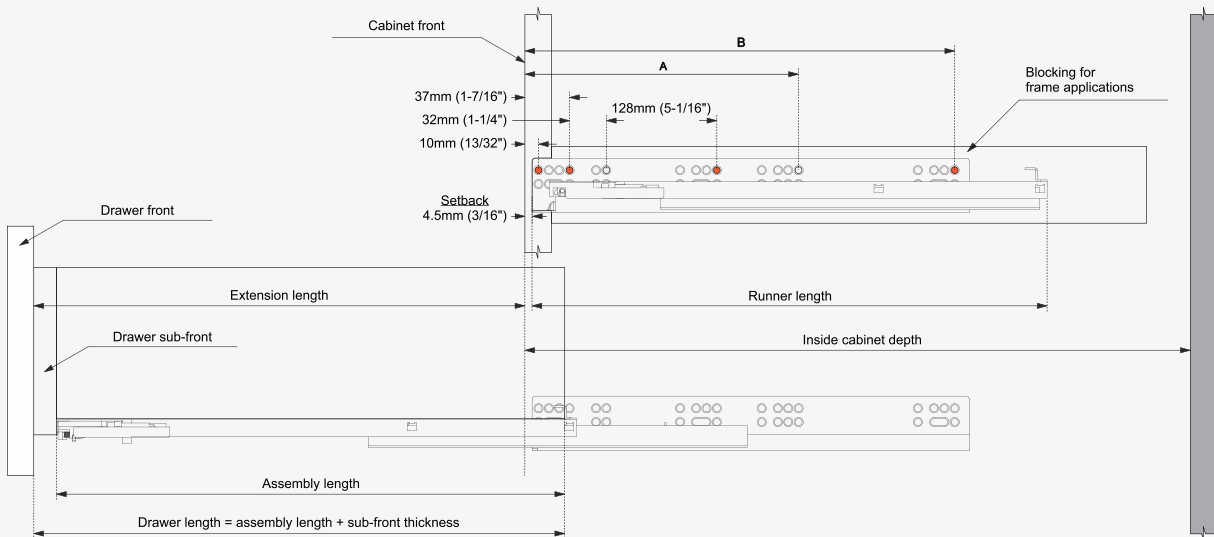

Note: The orange dots show the locations where fixing screws should be installed to achieve the specified load ratings

Runner SKU number	Nominal length	Runner length	Assembly length	Extension length	Screw locations for frameless cabinet		Inside cabinet depth Minimum
					A	B	
TCH-23303.S 16.457.3D	457mm (18")	470mm (18-1/2")	441mm (17-3/8")	419mm (16-1/2")	-	261mm (10-9/32")	495mm (19 1/2")
TCH-23303.S 16.533.3D	533mm (21")	546mm (21-1/2")	517mm (20-3/8")	495mm (19-1/2")	261mm (10-9/32")	325mm (12-13/16")	572mm (22 1/2")
TCH-23303.S 16.610.3D	610mm (24")	623mm (24-1/2")	594mm (23-3/8")	572mm (22-1/2")	261mm (10-9/32")	421mm (16-9/16")	648mm (25 1/2")